

MATERIAL:
DUCTILE IRON / ALUMINUM
VITON

3" OPW A32R LIQUID LOADER

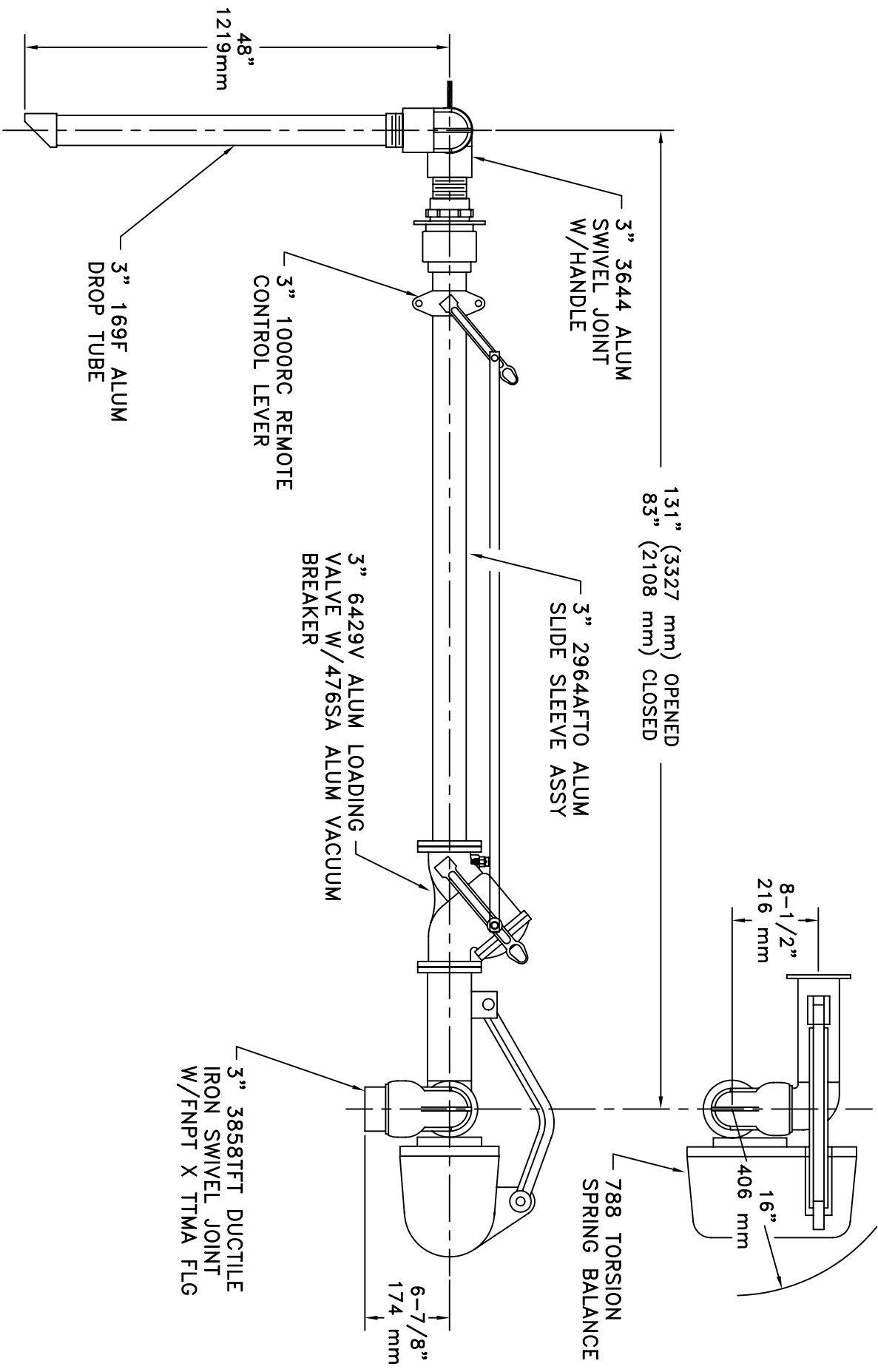

ARM IS DESIGNED FOR PRODUCT RETENTION TO POINT OF VALVE